

SPEKTRUMTM



**2-Channel, 2-Model Memory
DSM Racing System**

Table of Contents

Alternate Languages.....	2
Introduction	3
DX2 Quick Start Setup	3
DX2 with Digital Spectrum Modulation	6
Binding	6
Antenna.....	7
Direct Trim Access	8
Control Identification and Location	9
System Features.....	10
R/C Safety Precautions	10
Steering Tension Adjustment.....	10
Receiver Connections and Installation	11
Servo Layout.....	12
Charging Jack.....	12
Key Input and Display	12
Display Screens	13
Accessing the System Mode	15
Model Name Entry (System Mode)	16
Data Reset (System Mode).....	17
Accessing the Function Mode.....	18
Mode Key.....	18
Model Select (Function Mode).....	19
Travel Adjust (Function Mode).....	20
Steering Rate (Function Mode)	22
Sub-Trim (Function Mode).....	23
Servo Reversing (Function Mode).....	24
Accessing the Direct Trim Mode.....	25
Steering Trim (STT).....	26
Throttle Trim (THT).....	27
Grip Lever B: Steering Dual Rate Trim Adjustment STG.....	28
Grip Lever A: Brake Endpoint Adjustment BRG Brake Endpoint Adjustment	29
DX2 Data Sheet	30
Warranty and Service Information	31

Alternate Languages

ITALIAN: Per la versione italiana di questo manuale vi preghiamo di visitare il sito www.spektrumrc.com

FRENCH: Pour consulter ce manuel en français, visiter le site www.spektrumrc.com

GERMAN: Zur Ansicht der Bedienungsanleitung in den Deutsch besuchen Sie bitte www.spektrumrc.com

SPANISH: Para ver este manual en Español entra en www.spektrumrc.com

Introduction

Thank you for purchasing Spectrum's DX2 radio system. The DX2 is designed to provide R/C racers with a bulletproof 2.4GHz spread spectrum radio link. With the DX2 DSM system you'll no longer have to wait for a frequency clip, worry about radio interference from noisy motors or ESCs or be concerned that someone may turn on a radio on your channel causing interference. In addition, the DX2's programming is user-friendly and offers the most important features and functions that racers demand. It's important that you carefully read this manual before attempting to operate your DX2 system. For your convenience, a blank data sheet has been included in the back of this manual. Once you have input all the necessary data for a particular model, we recommend that you write that information down on the data sheet provided. This insures that, in the rare case of a memory failure, you will not lose your models' setup data.

For those who would like to get out to the track quickly with just the basic radio setup, please refer to the Quick Start section that follows.

DX2 Quick Start Setup

Included in this manual are in-depth instructions detailing all the steps and procedures needed to program each of the DX2's functions. For those racers who want to get to the track fast, we have provided the Quick Start section below. Quick Start covers the basic programming information necessary to get you racing right away.

Later, when you want to learn more about the specific functions of the DX2, refer to the appropriate page(s) in this manual for more detailed programming information.

Binding

It's necessary to program the receiver to a specific transmitter so that the receiver will only recognize that transmitter, ignoring signals from any other sources. If the receiver is not bound to a transmitter, the system will not operate. Also, during the binding process, the servo fail-safe positions are set.

1. Make sure the transmitter and receiver are turned off.
2. With the receiver off, press and hold the bind button on the receiver while turning on the receiver.
3. Release the bind button when the LED flashes green.
4. With the transmitter off, Place the transmitter steering wheel, throttle trigger and auxiliary channels in their desired fail-safe positions (normally brake and straight ahead steering).
5. Press and hold the bind button on the transmitter while turning on the transmitter.
6. Release the bind button after the green LED flashes.

After several seconds the LED on the receiver and the LED on the transmitter will quit flashing and remain solid, indicating that the binding process was successful. Once binding is complete, the system will automatically connect.

Note: See page 6 for a detailed description of the binding process.

DX2 Quick Start Setup (continued)

Servo Reversing

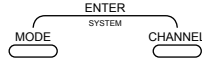
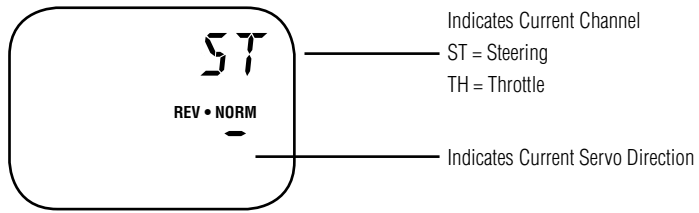

1. With the transmitter power switch on, press the **MODE** key to enter the Function Mode.

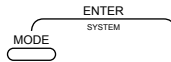

2. Press the **MODE** key until ST REV.NORM appears on the screen. The ST REV.NORM indicates the steering servo reversing screen.

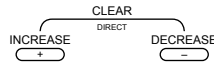

3. Press the **INCREASE** or **DECREASE** key to move the cursor to the desired servo direction (REV.NORM).

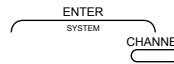

4. Press the **CHANNEL** key once to access the throttle servo reversing screen.

5. To select the direction of the throttle servo, repeat Step 3 above.

DX2 Quick Start Setup (continued)

Travel Adjustment

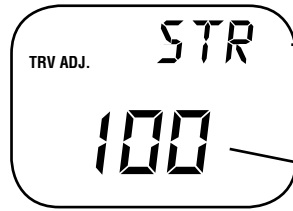

- Indicates Current Adjustment Position
- STR = Steering Right
- STL = Steering Left
- FWD = Forward Trigger
- BRM = Reverse (brake) Trigger

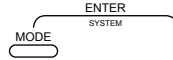

1. From the Servo Reverse function, press the **MODE** key twice to access the Travel Adjustment function (the STL or STR screen will appear).

Steering Adjustment

2. Rotate the steering wheel in the desired direction (left or right) to be adjusted.

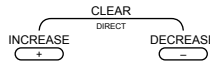

3. Press the **INCREASE** or **DECREASE** keys to select the desired travel value.

Throttle/ Brake Adjustment

4. Press the **CHANNEL** key once. FWD will appear on the screen.

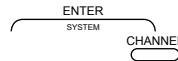

5. Press the **INCREASE** or **DECREASE** keys to select the desired travel value.

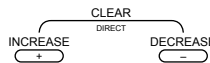

6. Move the throttle trigger to full brake and hold, noting that the screen now displays BRM. Adjust the brake value by pressing the **INCREASE** or **DECREASE** keys to obtain the desired full brake position.
7. Press the **MODE** and **CHANNEL** keys at the same time to exit the function mode.

DX2 with Digital Spectrum Modulation

The DSM system operates in the 2.4GHz band (that's 2400MHz). This high frequency offers a significant advantage as it's well out of the range of model-generated radio interference (like motor and ESC noise). All the complex issues that now exist using 27 and 75MHz radios with model-generated interfering noise are eliminated with this system. The DSM system uses Direct Sequencing Spread Spectrum modulation to generate a wide signal on a single frequency. The FCC requires that these systems be "smart"—incorporating collision avoidance such that when a system is turned on, it scans the 2.4GHz band and selects a channel that is not being used, then begins transmitting on that unused channel. 79 channels are available and the odds of one DSS spread spectrum system interfering with another are astronomically remote. The 2.4GHz spectrum has a capacity of 79 channels. In the unlikely event that the spectrum is full, the 80th system will not connect or cause any interference going into hold scan until a channel is free.

Binding

During the first installation, the receiver(s) must be bound to the transmitter. Binding is necessary to program the receiver(s) to distinguish its corresponding transmitter from others. Also fail-safe positions are transferred from the transmitter to the receiver during binding. See binding below for more details.

It is necessary to bind the receiver to the transmitter during the first installation, and is recommended when the receiver is moved from one vehicle to another. Receivers can be re-bound to the same transmitter or to other transmitters an infinite number of times. Also multiple receivers can be bound to a single transmitter, common when using one transmitter to operate several models.

Only bound receivers and transmitters can connect. During power-up, the transmitter scans for a free channel while the receiver scans for its bound transmitter. During the scanning process LEDs on both transmitter and receiver flash rapidly. When control is achieved the LED remains on continuously.

In the unlikely event that the link is lost during use, the receiver will drive the servos to their fail-safe positions that were preset during the binding process. If the receiver is turned on prior to turning on the transmitter, the receiver will enter the fail-safe mode, driving the servos to their preset fail-safe position. When the transmitter is turned on, normal control is resumed.

To bind the receiver to the transmitter

1. Make sure the transmitter and receiver are turned off

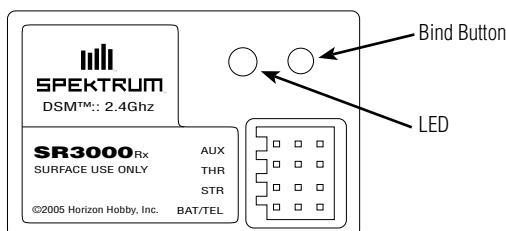

2. With the receiver off, press and hold the bind button on the receiver while turning on the receiver.
3. Release the bind button when the LED flashes green.

Binding (continued)

4. With the transmitter off, place the transmitter steering wheel and throttle trigger channels in their desired fail-safe positions (normally brake and straight ahead steering).

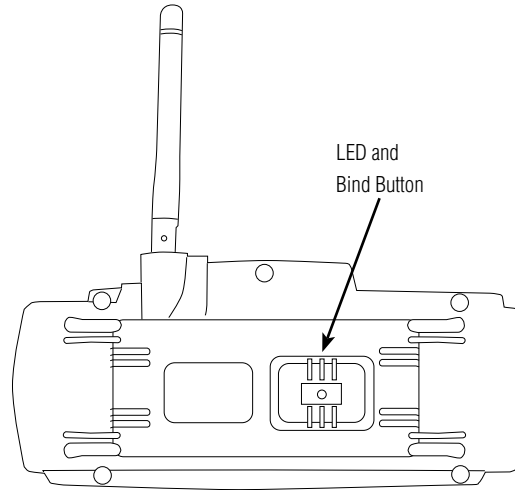

5. Press and hold the bind button on the transmitter while turning on the transmitter.
6. Release the bind button after the green LED flashes

After several seconds the LED on the receiver and the LED on the transmitter will quit flashing and remain solid, indicating that the binding process was successful. Once binding is complete, the system will automatically connect.

Antenna

At 8.5 inches in length, the receiver antenna is significantly shorter than conventional antennas. The receiver has provisions that allow the antenna to exit the top of the receiver or at the end of the receiver. To switch antenna positions it is necessary to open the case to change the antenna exit position. Like all antennas, it's important to mount the antenna vertically. In most cases the antenna can be mounted inside the body with no loss of range. Mount the receiver antenna as recommended by the manufacturer of the vehicle, however, it may be necessary to trim the plastic antenna tube (included with your vehicle) to allow the antenna to extend at least 1/2" past the tip of the tube.

Note: If desired, the antenna can be shortened (cut) to exactly 3.6" with negligible loss of range, and in some applications the short 3.6" length will make installation easier.

Direct Trim Access

Servo Trim Adjustment

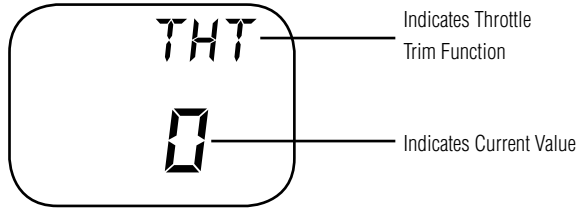
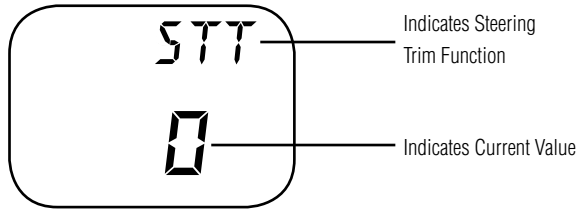

Steering Servo Trim Adjustment:

1. With the transmitter power switch on, move the digital steering trim lever in the desired position to be adjusted. The steering trim value screen will appear automatically.

Throttle Servo Trim Adjustment:

2. With the transmitter power switch on, move the digital throttle trim lever in the desired position to be adjusted. The throttle trim value screen will appear automatically.

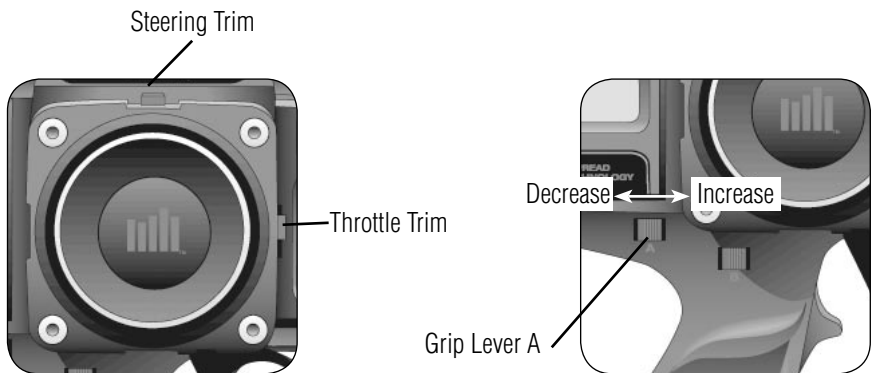

Control Identification and Location

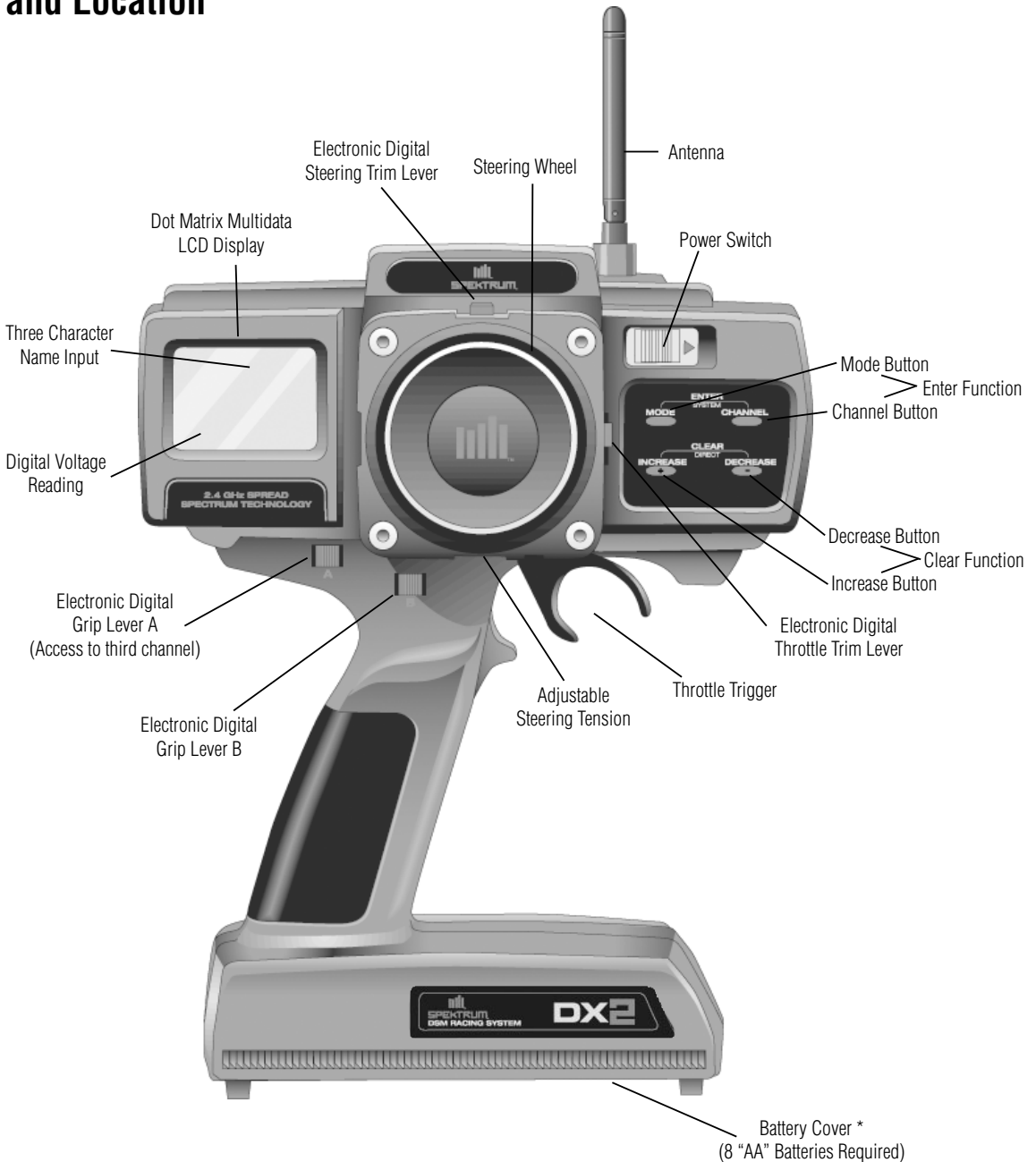

* To remove the Battery Cover, press down where it says “press” and push the cover in the direction of the arrow. Remove the battery case and install 8 “AA” batteries in the direction as molded into the battery case. If transmitter voltage fails to register, check for correct battery installation and voltage.

System Features

- DSM 2.4GHz Spread Spectrum Modulation
- Two channels
- Easy-to-read LCD graphics display
- Two-model memory
- Three-character model name entry
- Electronic digital trim levers for throttle and steering
- Two assignable electronic grip levers
- Direct display trim function
- Sub-trim
- Steering dual rate
- Independent steering endpoint adjustments
- Brake/throttle endpoint adjustment
- Low battery alarm
- Charge jack receptacle (rechargeable batteries not included; order JRPB958)

R/C Safety Precautions

For safe and reliable performance of your R/C model, please carefully read and follow these guidelines:

1. Radio control models are not toys. They are capable of inflicting serious injury to people and property. Use caution at all times when operating your model.
2. You are responsible for the safe operation of your R/C model. You must properly install, test and operate your model with a clear sense of that responsibility. Do not take risks that might endanger yourself or others.
3. Running an R/C car in the streets is very dangerous to both drivers and models. Avoid running your model in areas occupied by full-size automobiles. To locate areas where you can safely operate your model, you should contact your local hobby shop for R/C tracks or clubs in your area.
4. When running an R/C boat, keep it away from any swimmers, full-size boats, or wildlife. Also, watch carefully for fishing lines that can get tangled in the propeller.

CAUTION: Control of your model is impossible without sufficient voltage for the transmitter and receiver. A weak transmitter battery will decrease your range of operation and a weak receiver battery will slow servo movement and decrease your range of operation. Check your receiver pack voltage often to avoid losing control of your model.

Steering Tension Adjustment

Steering tension is adjustable via the recessed screw located beneath the steering wheel (see page 9 for exact location). Turning the screw clockwise increases the steering tension.

Receiver Connections and Installation

Note: When using a separate receiver Ni-Cd as a power source, the operating voltage range is 4.8–6.0V (4–5 cells)

Attention: Make sure the male and female connectors have the correct polarity (+/–) before connecting. Be sure to orient the servo plug correctly for proper insertion.

Most electronic speed controllers are set up for B.E.C. operation and plug directly into your receiver. See Figure A for a typical setup and check your speed controller’s manual for correct installation.

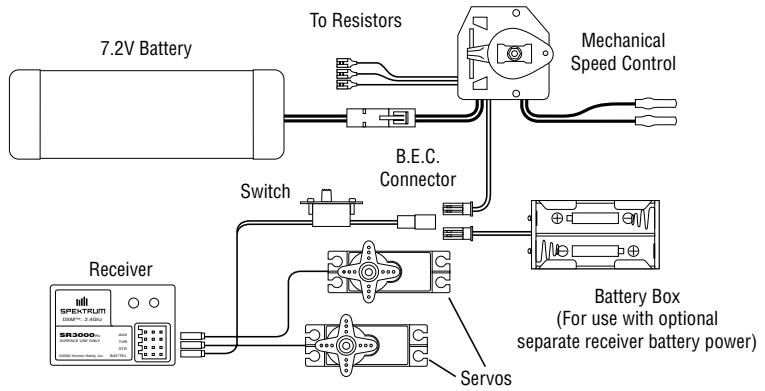

Figure A – Connections to B.E.C. and receiver with mechanical speed controller. Ni-Cd battery and speed controller are not included in the radio set.

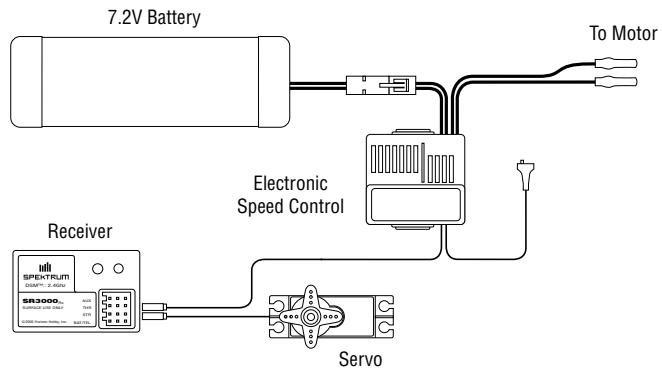
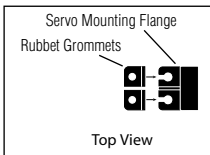
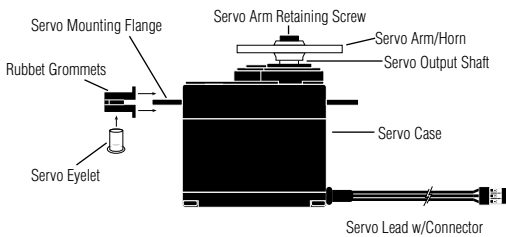

Figure B – Connections to B.E.C. and receiver with electronic speed controller. Ni-Cd battery and speed controller are not included in the radio set.

Servo Layout

Note: Rubber grommets (and sometimes eyelets) are used in fuel-powered vehicles.



Charging Jack

Located on the right-hand side of the transmitter is the charging jack, which accepts only JR® style wall chargers. Please do not attempt to use any other brand of wall charger as it may be reverse polarity and can cause damage to your system. Only use the JR type wall charger when the DX2 is equipped with Ni-Cd batteries (available separately, JRPB958).

Spektrum Transmitter Charge Jack Polarity:



Key Input and Display

Key	Use
MODE	Used to move up through the available functions
CHANNEL	Used to select the desired channel
INCREASE	Used to increase the value of the selected function
DECREASE	Used to decrease the value of the selected function

To enter the System Mode press the **MODE** and **CHANNEL** keys simultaneously and hold while turning on the transmitter.

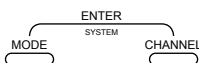

To enter the Function Mode press the **MODE** key while the transmitter is on.

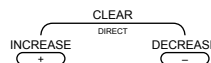

Press the **INCREASE** and **DECREASE** keys simultaneously to clear the screen or return to factory preset.

Display Screens

Normal Display Screen

When the power switch is turned on, the LCD screen will read as shown below. This screen is referred to as the Normal Display.

Note: If any of the electronic trim buttons are moved while in this screen, the screen will automatically change to display the trim in use. This is called the Direct Trim Mode. For more information on the feature, please see page 8 of this manual.

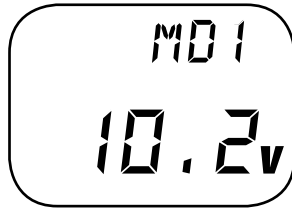

Low Battery Screen/Lithium Battery Backup

When the voltage of the eight "AA" batteries drops below 9.0 volts, the DX2's display screen will alternate between the Normal (see above) and Low Battery screen (BAT), and a continuous beeping will occur, indicating that the batteries need to be replaced before further use.

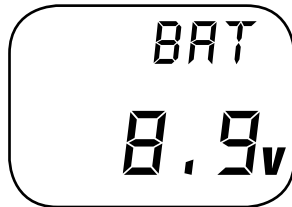

Display Screens (continued)

Lithium Battery

Your DX2 radio system is equipped with a five-year lithium battery backup system. This system is designed to protect and retain all radio programming in the event that the transmitter batteries drop below the required 9.0 volts, or the transmitter battery case is removed during battery changes. If after five years it becomes necessary to replace the lithium battery, return your system to the Horizon Service Center for repair (see address, page 31).

Memory Backup Screen

If the Memory Backup screen appears, this indicates the possibility of a memory issue or the lithium battery is dead. If you switch the power off and on again, and transmitter is in the default mode with all data lost, it is suggested that the DX2 transmitter be returned to the Horizon Service Center for servicing (see Warranty Information, page 31).



Accessing the System Mode

To enter the System Mode, press both the **MODE** and **CHANNEL** keys at the same time while turning on the transmitter power switch. By pressing the **MODE** key, you can now select the model name input, data reset function as shown here on the System Mode flow chart. Information for each function is located on the page number listed next to the function name on the flow chart.

To exit the System Mode, press the **MODE** and **CHANNEL** keys at the same time, or simply turn off the transmitter.

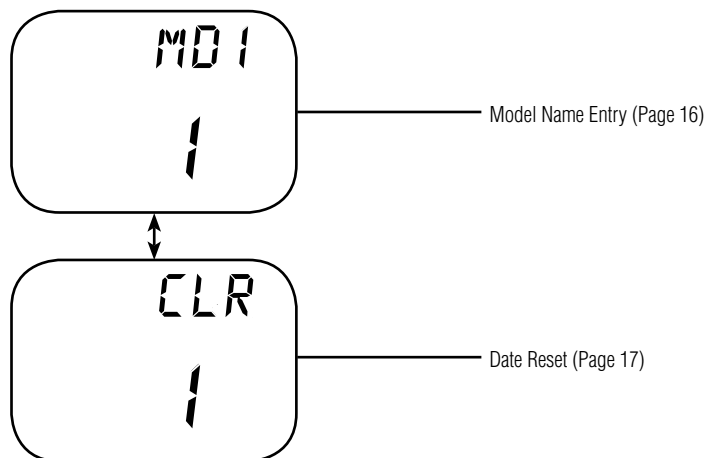

Model Name Entry (System Mode)

The DX2 allows a three-character name to be input for each of the two (2) models available. The current model, with name, will then be displayed in the Normal display screen. This feature is useful to help identify different models, setups, etc. For information on selecting models 1 or 2, please refer to the Model Select Function (page 19).

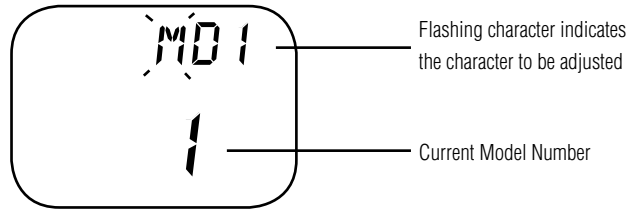

Accessing the Model Name Entry Function

To access the Model Name Entry function, follow the steps below:

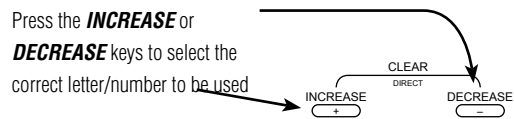
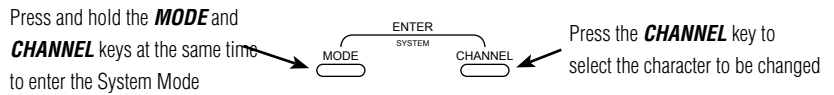

1. Press the **MODE** and **CHANNEL** keys at the same time and hold.
2. Turn on the transmitter power switch to enter the System Mode.
3. MD1 should now be present on the screen.
4. Press the **INCREASE** or **DECREASE** keys to select the correct letter/number for the first character (flashing).
5. To change the remaining two characters, press the **CHANNEL** key until the desired character to be changed is flashing.
6. To access the Data Reset function, press the **MODE** key. To exit the System Mode, either turn the transmitter power switch off or press the **MODE** and **CHANNEL** keys at the same time.

Data Reset (System Mode)

The Data Reset function allows you to reset all the programming in the selected model (1 or 2) to the factory default settings. Before using the Data Reset function, it's important to enter the Model Select function and check to make sure the current model number indicated (1 or 2) is the model to which you want to reset to the factory default settings. The Model Select function is described in detail on page 19.

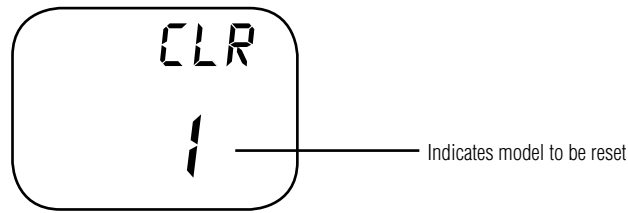

Accessing the Data Reset Function

To access the Data Reset function, follow the steps below:

Press the **MODE** key to access the Model Name Entry function

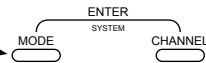

Press the **INCREASE** or **DECREASE** keys at the same time to reset (clear) all settings for the selected model to the factory default

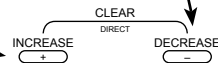

1. Press the **MODE** and **CHANNEL** keys at the same time and hold.
2. Turn on the transmitter power switch to enter the System Mode.
3. Press the **MODE** key once until CLR appears on the screen.
4. Press the **INCREASE** and **DECREASE** keys at the same time to reset the data. To confirm that the selected model's programming has been reset, a beep will sound and the model number selected (1 or 2) will stop flashing.
5. To exit the System Mode, either turn the transmitter power switch off or press the **MODE** and **CHANNEL** keys at the same time.

Accessing the Function Mode

To enter the function mode, it's necessary to first turn on the transmitter's power switch. Next, press the **MODE** key until a beep is heard. The display will change to show the first function listed on the Function Mode flow chart as shown below. Press the MODE key to scroll down through the functions one by one, as shown in the flow chart. Once the desired function has been reached, use the channel key to select the appropriate channel (if applicable). To adjust the values of the function, simply press the **INCREASE (+)** or **DECREASE (-)** keys until the desired value is displayed on the screen.

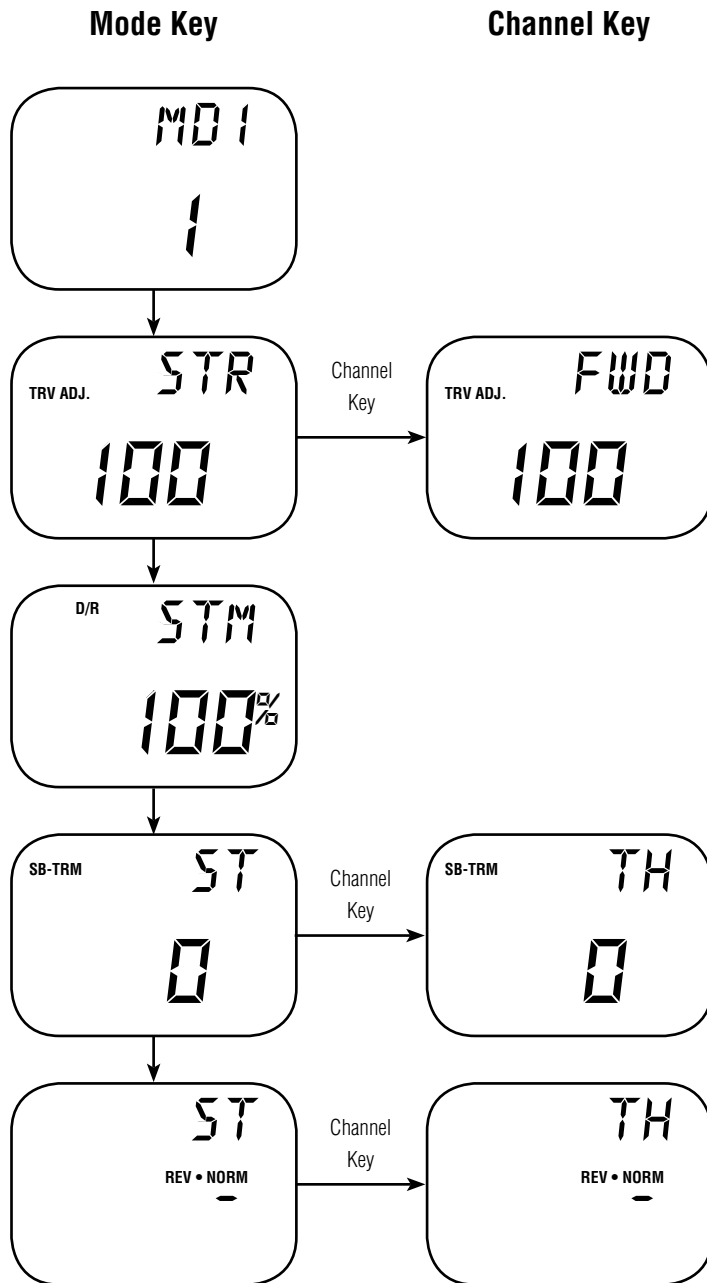

Model Select (Function Mode)

The DX2 has memory for two (2) models. This feature allows for two different models to be operated with the same transmitter (additional receivers and servos must be purchased separately), or one model with two (2) different race setups.

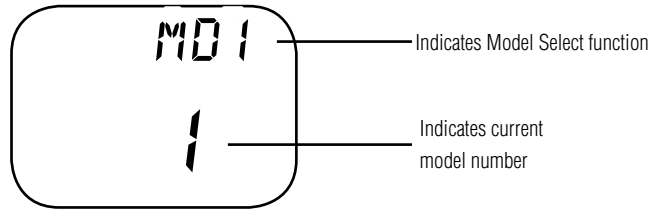

Accessing the Model Select Function

To access the Model Select function, follow the steps below:

Press the **MODE** key until MDL appears on the screen

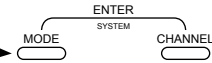

Press the **INCREASE** or **DECREASE** keys to select the desired model to be used (1 or 2)

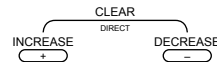

1. Turn the transmitter power switch on.
2. Press the **MODE** key to access the Function Mode.
3. Press the **MODE** key until MDL appears on the screen.
4. Press the **INCREASE** or **DECREASE** keys to select the desired model number (1 or 2).
5. Press the **MODE** key to access the Travel Adjust function.
6. To exit the Function Mode, either turn off the transmitter power switch or press the **MODE** and **CHANNEL** keys at the same time.

Travel Adjust (Function Mode)

The Travel Adjust feature of the DX2 allows the maximum travel of both the steering or throttle. The adjustment range is from 0 % to 125%. The travel adjustment is factory set to 100% for both channels. The travel adjustment value displayed on the screen depends on the current position of the steering wheel, trigger, or trim lever to be adjusted. This feature is very useful either to maximize servo travel or to reduce servo over-travel to eliminate servo binding (servo moves further than control mechanism allows), without the need for mechanical linkage adjustment.

The screens below are accessed by turning the wheel to the desired direction to be adjusted (left or right), by moving the trigger to the forward or backward (brake) position, or by moving the Grip Lever A to the forward or back positions.

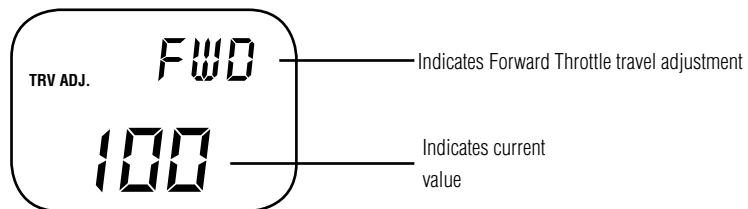
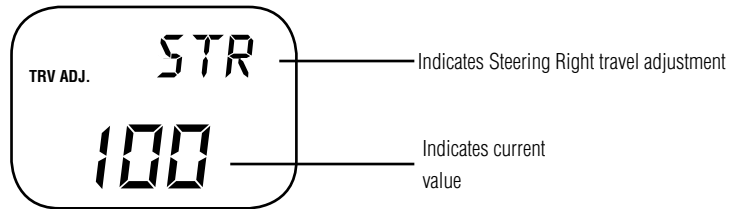
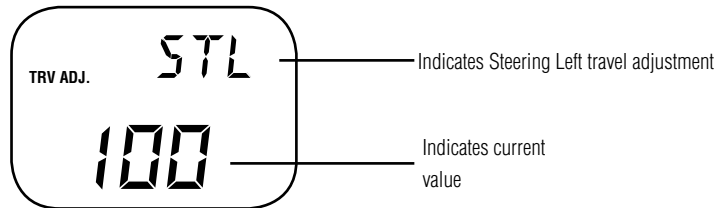

Travel Adjust (Function Mode) (Continued)

Accessing the Travel Adjust Function

To access the Travel Adjust feature, follow the step below:

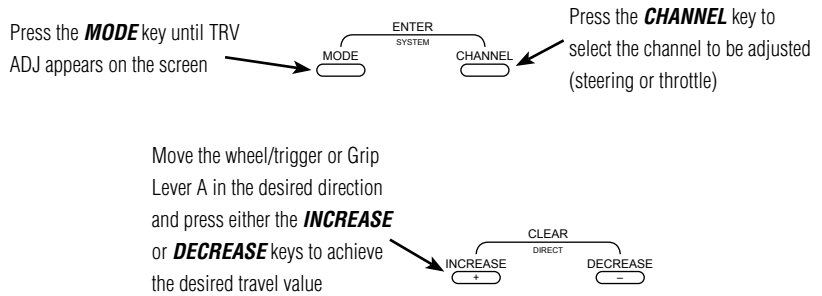

1. Turn on the transmitter power switch.
2. Press the **MODE** key to enter the Function Mode.
3. Press the **MODE** key until TRV ADJ appears in small letters on the left side of the screen.
4. Press the **CHANNEL** key to select the desired channel to be adjusted. Steering = STR (steering right) or STL (steering left); Throttle = FWD (forward) or BRM (braking or reverse)
5. Move the steering wheel, trigger or Grip Lever A in the desired direction for adjustment (left/right, forward/reverse or brake). Press the **INCREASE** or **DECREASE** key to achieve the desired amount of travel. Move the wheel, trigger or Grip Lever A in the opposite direction to adjust the travel in the opposite direction.
6. Press the **MODE** key to access the Steering Dual Rate function.
7. To exit the Function Mode, either turn off the transmitter power switch or press the **MODE** and **CHANNEL** keys at the same time.

Note: When setting the travel adjust values for the steering function, it's suggested that if possible the maximum travel values be set to an equal value in both directions to maintain proper steering control.

Steering Rate (Function Mode)

The Steering Rate feature of the DX2 allows the steering servo travel to be increased or decreased to the desired amount required. The values of the Steering Rate function are a percentage based from the travel adjust value set in the Travel Adjust section.

Example: Travel adjust value 100%, Steering value 80% — Maximum steering rate is now reduced to 80% of the maximum travel value (100%)

The Steering Rate function also works in conjunction with the Grip Lever B Steering Rate function (page 28) and acts as the maximum rate available through Grip Dial B. This feature allows the steering rate to be increased or decreased directly from the Grip Lever B while racing to maximize the steering rate needed for the particular track conditions.

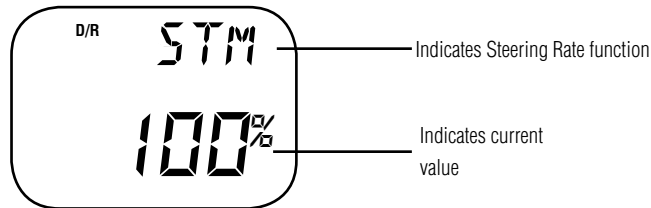

Accessing the Steering Rate Function

To access the Steering Rate Function, follow the steps below:

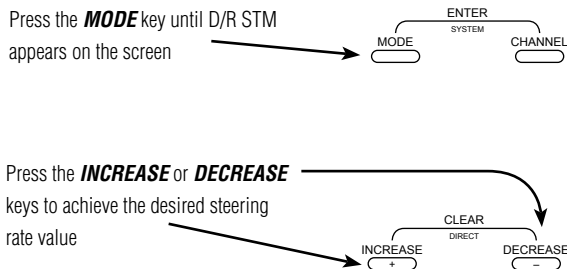

1. Turn on the transmitter power switch.
2. Press the **MODE** key to enter the Function Mode.
3. Press the **MODE** key until D/R STM appears on the screen.
4. Press the **INCREASE** or **DECREASE** keys until the proper steering rate is achieved.
5. Press the **MODE** key to access the Sub-Trim function.
6. To exit the Function Mode, either turn off the transmitter power switch or press the **MODE** and **CHANNEL** keys at the same time.

Sub-Trim (Function Mode)

The Sub-Trim function of the DX2 is an electronic trimming feature that allows the neutral position of the servo on the steering, throttle to be moved, while allowing the electronic trim lever for that channel to remain in the center position. This feature is very useful as it allows the servo arm/wheel position to be moved to help with control linkage installation, eliminating the need to make mechanical linkage adjustments.

Although the Sub-Trim function is a very useful feature, it is suggested that only small amounts of sub-trim be used so that no unwanted, non-equal servo travel is created. It's suggested that less than 30 points of sub-trim be used during adjustment. If more than 30 points of sub-trim are required, it's suggested that a mechanical linkage adjustment be performed.

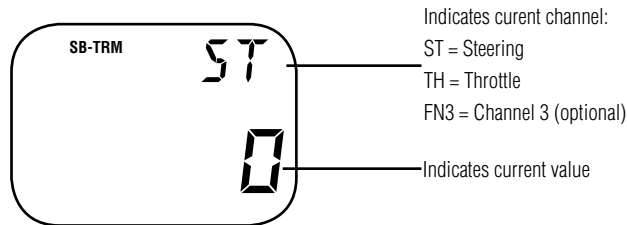

Accessing the Sub-Trim Function

To access the Sub-Trim function, follow the steps below:

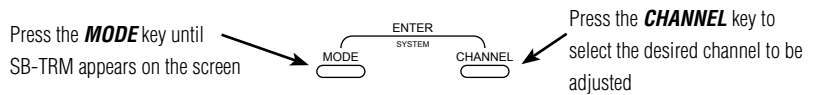

ST = Steering
TH = Throttle

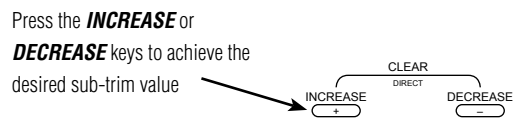

1. Turn on the transmitter power switch.
2. Press the **MODE** key to enter the Function Mode.
3. Press the **MODE** key until SB-TRIM appears in small letters to the left of the screen.
4. Press the **CHANNEL** key to select the channel to be adjusted (ST= Steering, TH= Throttle).
5. Press the **INCREASE** or **DECREASE** keys until the proper servo position is achieved.
6. Press the **MODE** key to access the Servo Reversing function.
7. To exit the Function Mode, either turn off the transmitter power switch or press the **MODE** and **CHANNEL** keys at the same time.

Servo Reversing (Function Mode)

The Servo Reversing feature of the DX2 is a very convenient feature when setting up a new model. The purpose of the servo reversing function is to change the direction of the servo rotation in relation to the wheel/trigger movement. The Servo Reversing function is available for the steering and throttle of the DX2.

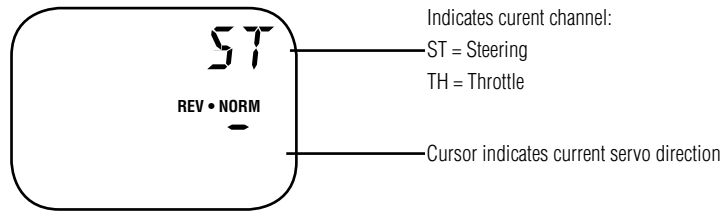

Accessing the Servo Reversing Function

To access the Servo Reversing function, follow the steps below:

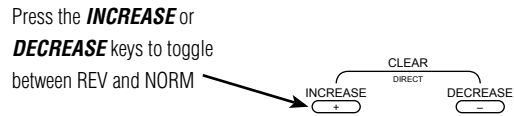
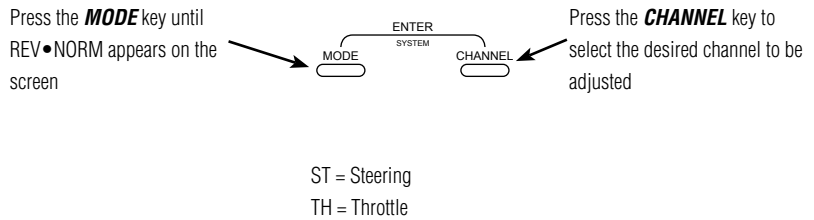

1. Turn the transmitter power switch on.
2. Press the **MODE** key to access the Function Mode.
3. Press the **MODE** key until REV.NORM appears in small letters to the right of the screen.
4. Press the **CHANNEL** key to select the channel to be changed (ST = Steering, TH = Throttle).
5. Press the **INCREASE** or **DECREASE** keys to move the cursor to the desired direction.
6. To exit the Function Mode, either turn off the transmitter power switch or press the **MODE** and **CHANNEL** keys at the same time.

Accessing the Direct Trim Mode

The Direct Trim Mode function of the DX2 is accessible through the use of the electronic throttle or steering trim levers, as well as the two electronic grip levers (A&B) located on the upper portion of the grip handle. This function allows for quick trim adjustment of these controls, without the need to access these functions through the four keypad control keys.

To access the Direct Trim Mode function, turn on the transmitter power switch. Next, move the desired trim lever to be adjusted. The appropriate screen for the selected trim lever will be displayed. To adjust, simply move the trim lever in the desired direction until the correct amount of trim is achieved. Once the desired trim is achieved, the screen will return to the Normal display screen after approximately five seconds from the last trim input. If the **MODE** or **CHANNEL** keys are pressed any time during the five seconds, the system will return to the previous screen in use.

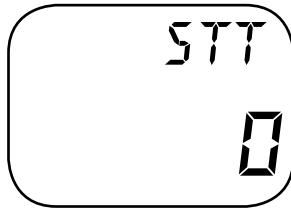

Steering Trim (Page 26)

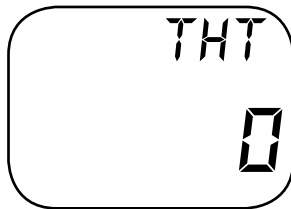

Throttle Trim (Page 27)

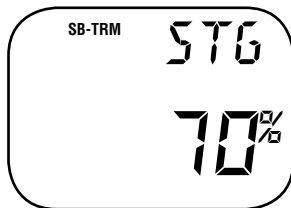

Steering Dual Rate (Grip Lever B (Page 28)

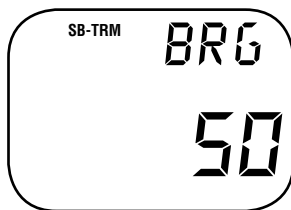

Brake Travel Adjustment (Grip Lever A), Page 29

Steering Trim (STT)

The DX2 electronic steering trim lever, located just above the steering wheel, allows the center position of the servo to be manipulated in either direction to achieve precise centering of the steering assembly. Steering Travel Adjustment values (page 20) remain completely independent from the steering trim, unless the trim value exceeds the selected endpoint values. (For example: If trim value is set at 40 and endpoint values at 30, steering trim will override/alter the endpoint value.)

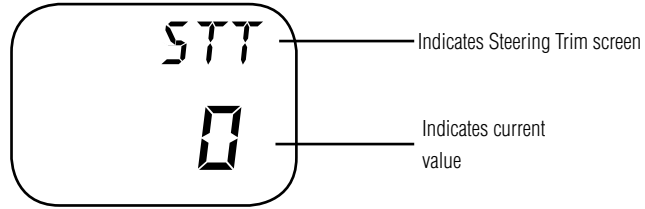

To adjust the steering trim servo position, move the electronic steering trim lever either to the left (+) or the right (-). As soon as the trim is moved, the STT steering trim screen will appear, and will continue to be displayed unless the trim lever is untouched for a period of five seconds. To reset the trim value to 0, press the **INCREASE** and **DECREASE** keys at the same time while the STT screen is displayed.

Press the **INCREASE** or **DECREASE** keys at the same time to reset the steering trim to 0

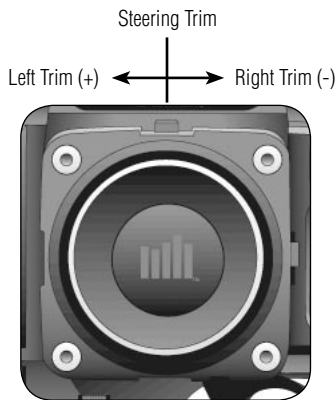
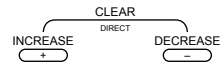

Throttle Trim (THT)

The DX2's electronic throttle trim lever, located to the right of the steering wheel, allows the center position of the servo to be manipulated in either direction to achieve precise centering of the throttle trigger neutral position. Throttle endpoint adjustment values (page 20) remain completely independent from the throttle trim, unless the trim value exceeds the selected endpoint values. (For example: If the trim value is set at 40 and the endpoint values at 30, throttle trim will override/alter the endpoint value.)

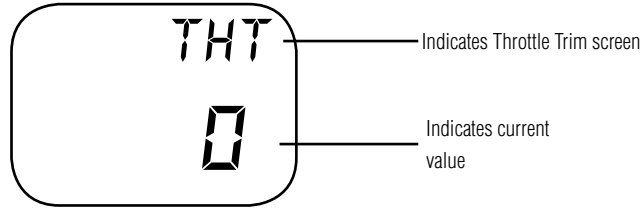

To adjust the throttle trim servo position, move the electronic steering trim lever either up (+) or down (-). As soon as the trim is moved, the THT throttle trim screen will appear and will continue to be displayed unless the trim lever is untouched for a period of five seconds. To reset the trim value to zero, press the **INCREASE** and **DECREASE** keys at the same time while the THT screen is displayed.

Press the **INCREASE** or **DECREASE** keys at the same time to reset the throttle trim to 0

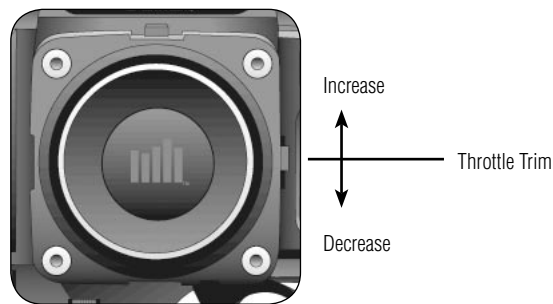
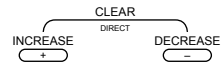

Grip Lever B: Steering Dual Rate Trim Adjustment STG

The steering dual rate adjustment, located at Grip Lever B, allows the dual rate value (maximum servo travel) to be increased or decreased within a range from 100% through 40% of the total dual rate value established in the Steering Rate function (page 22). This function is very useful in race conditions as it allows you to custom tailor the steering radius and sensitivity for the current track conditions. Please note that since the dual rate value shown in the STG screen is the percentage of the value established in the Steering Rate function, the value will not always increase or decrease, or beep once for each time the Grip Lever B is moved.

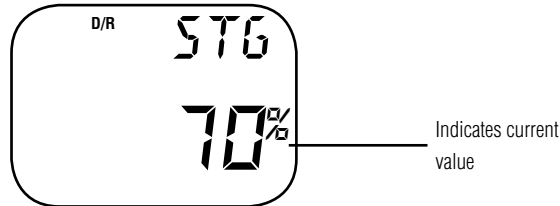

To adjust the steering dual rate value, move the electronic Grip Lever B either left (-) or right (+). As soon as the trim is moved, the STG steering dual rate screen will appear and will continue to be displayed unless the Grip Lever B is untouched for a period of five seconds. To reset the trim value to the factory preset setting of 70%, press the INCREASE and DECREASE keys at the same time while the STG screen is displayed.

Press the **INCREASE** or **DECREASE** keys at the same time to reset the throttle trim to 0

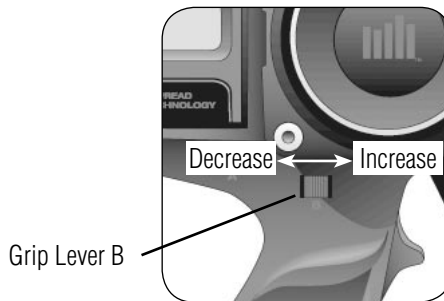
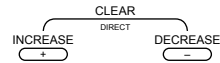

Grip Lever A: Brake Endpoint Adjustment BRG Brake Endpoint Adjustment

The brake endpoint adjustment, located at Grip Lever A, allows the maximum servo travel on the braking side of the throttle trigger to be increased or decreased from 100% to 0% (off). This function is very useful in race conditions as it allows the racer to custom tailor the “panic” brake value to maximize the car’s braking power for the current track conditions. Please note that since the brake endpoint value shown in the BRG screen is a percentage of the total braking value established in the Travel Adjust function (page 20), the value will not always increase or decrease, or beep once for each time the Grip Lever A is moved.

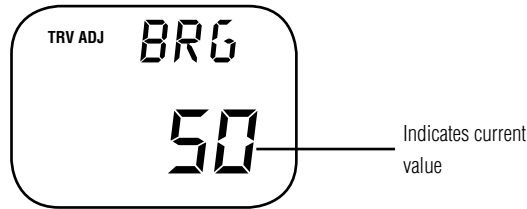

To adjust the brake endpoint value, move the electronic Grip Lever A either left (–) or right (+). As soon as the grip lever is moved, the BRG Travel Adjust screen will appear and will continue to be displayed unless the Grip Lever A is untouched for a period of five seconds. To reset the brake endpoint value to the factory preset setting of 50%, press the INCREASE and DECREASE keys at the same time while the BRG screen is displayed.

Press the **INCREASE** or **DECREASE** keys at the same time to reset brake endpoint trim value to the factory preset (50%)

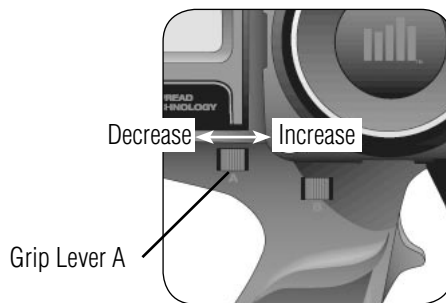
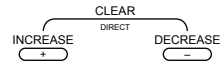

Move Grip Lever A to the left or right to decrease or increase values

DX2 Data Sheet

Use the programming sheet to record the information for the programs in your DX2 radio system. Feel free to make copies of this programming sheet.

<i>SYSTEM MODE</i>	1	2
MODEL NUMBER		
MODEL NAME		

<i>FUNCTION MODE</i>	STEERING		THROTTLE	
TRAVEL ADJUST	STR	STL	FWD	REV
STEERING DUAL RATE		%	 	
SUB-TRIM				
SERVO REVERSING	REV•NORM		REV•NORM	

<i>DIRECT MODE</i>	STEERING		THROTTLE	
TRIM VALUES		+/-		+/-
GRIP LEVER B STEERING D/R		%	 	
GRIP LEVER A VALUES	BRAKE TRAVEL ADJUST			
				%

Warranty and Service Information

Spektrum 1-Year Warranty

This Spektrum™ product is guaranteed against workmanship and manufacturing defects for a period of 1 year from the original date of purchase. This warranty is limited to the original purchaser and cannot be transferred. Warranty repair will cover all units except those that have been modified, misused, improperly installed, or serviced by an unauthorized service center. As with all fine electronics, avoid exposing your equipment to extreme temperatures, humidity, moisture, or exposure to direct sunlight for long periods of time.

If you have any questions about the operation or installation of this product, please feel free to call a product support representative at 1-877-504-0233.

If your equipment needs to be repaired, ship it to:

Horizon Service Center
ATTN: Spektrum Service
4105 Fieldstone Road
Champaign, IL 61822

Include your complete name and address information inside the carton and clearly write it on the outer label/return address area. Include a brief summary of the problem. Date your correspondence and be sure that your name and address appear on this enclosure. To receive warranty service, you must include your original sales receipt verifying the proof-of-purchase date. Providing warranty conditions have been met, your equipment will be repaired at no charge or replaced at the discretion of Horizon Hobby.

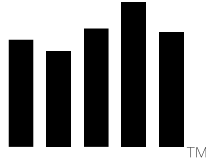

SPEKTRUMTM

HORIZON
H O B B Y



© 2005 Horizon Hobby, Inc.
4105 Fieldstone Road
Champaign, Illinois 61822
(877) 504-0233
horizonhobby.com