

PC-457AA

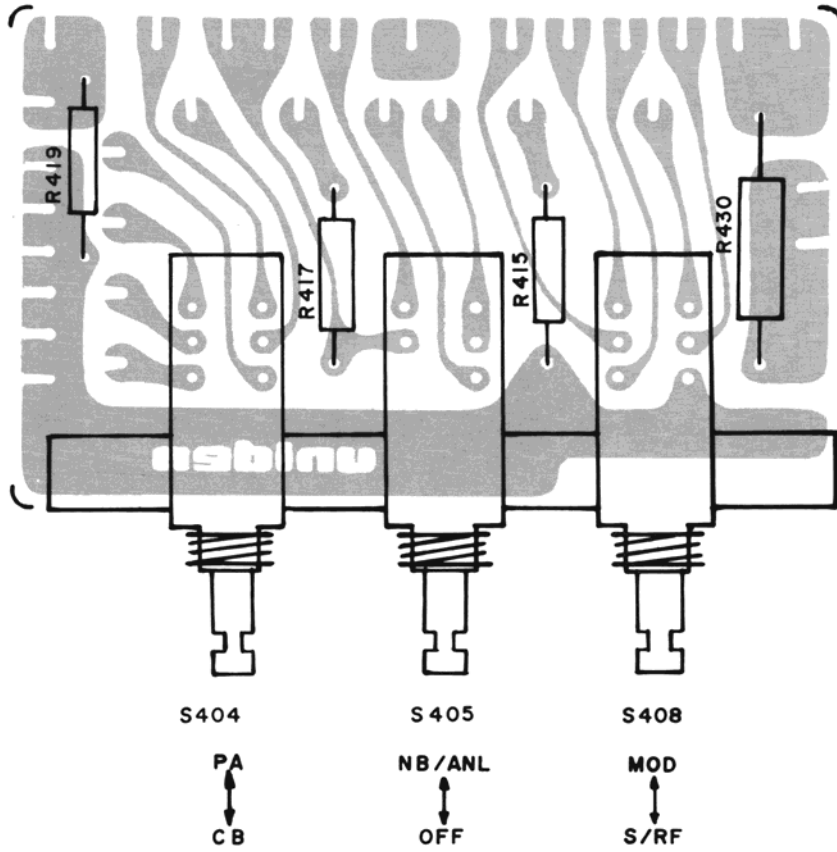

PC-372 AA

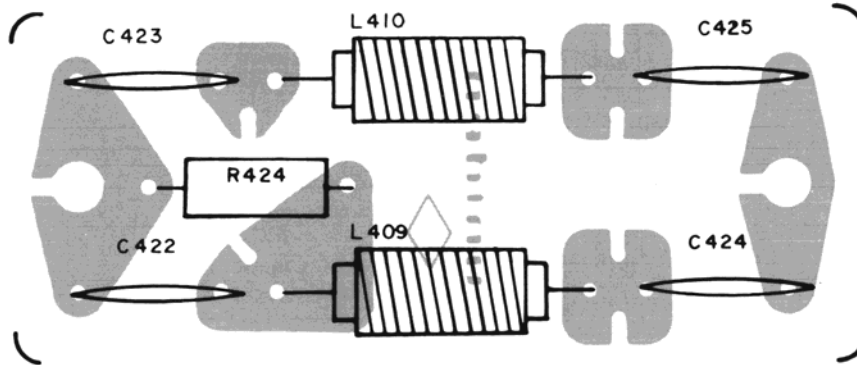

PC-006EB

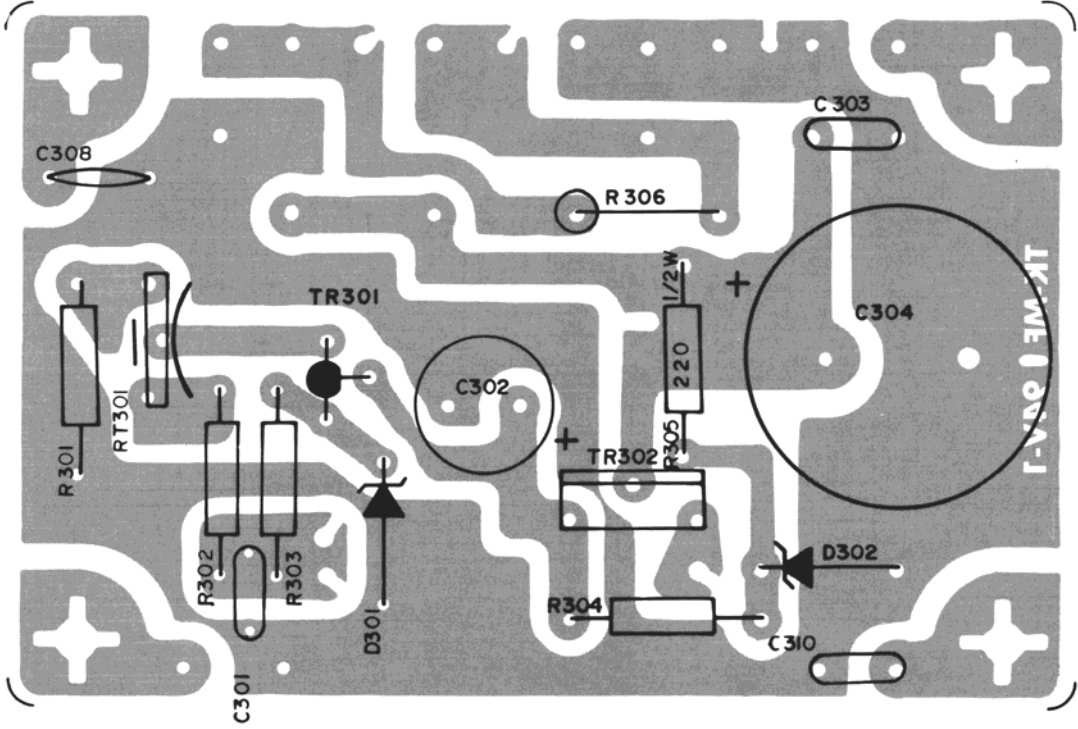

PC-401AA

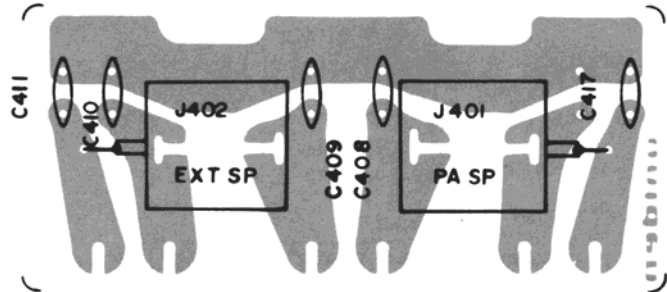

PC-385AD

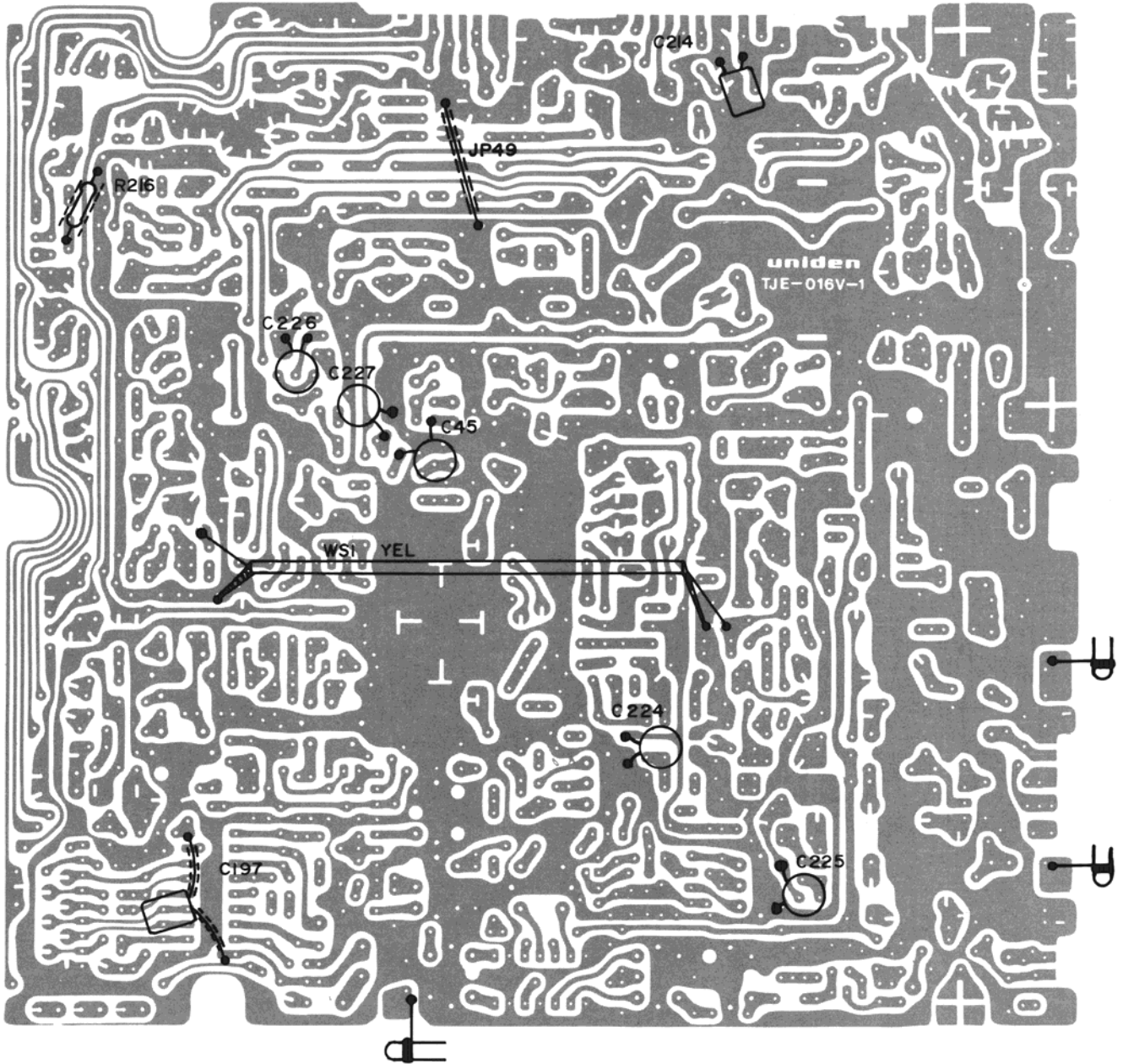

PC-385AD

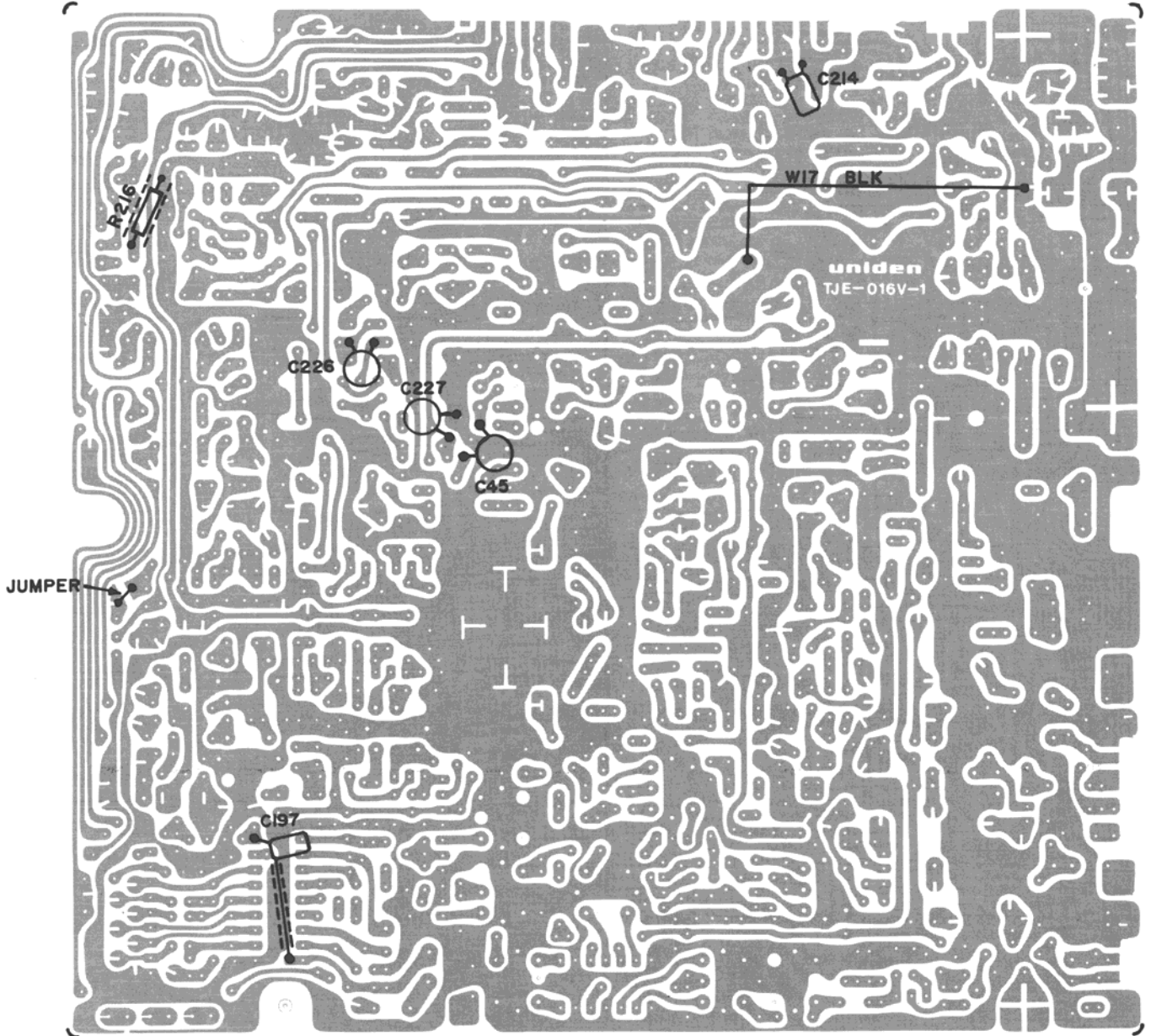

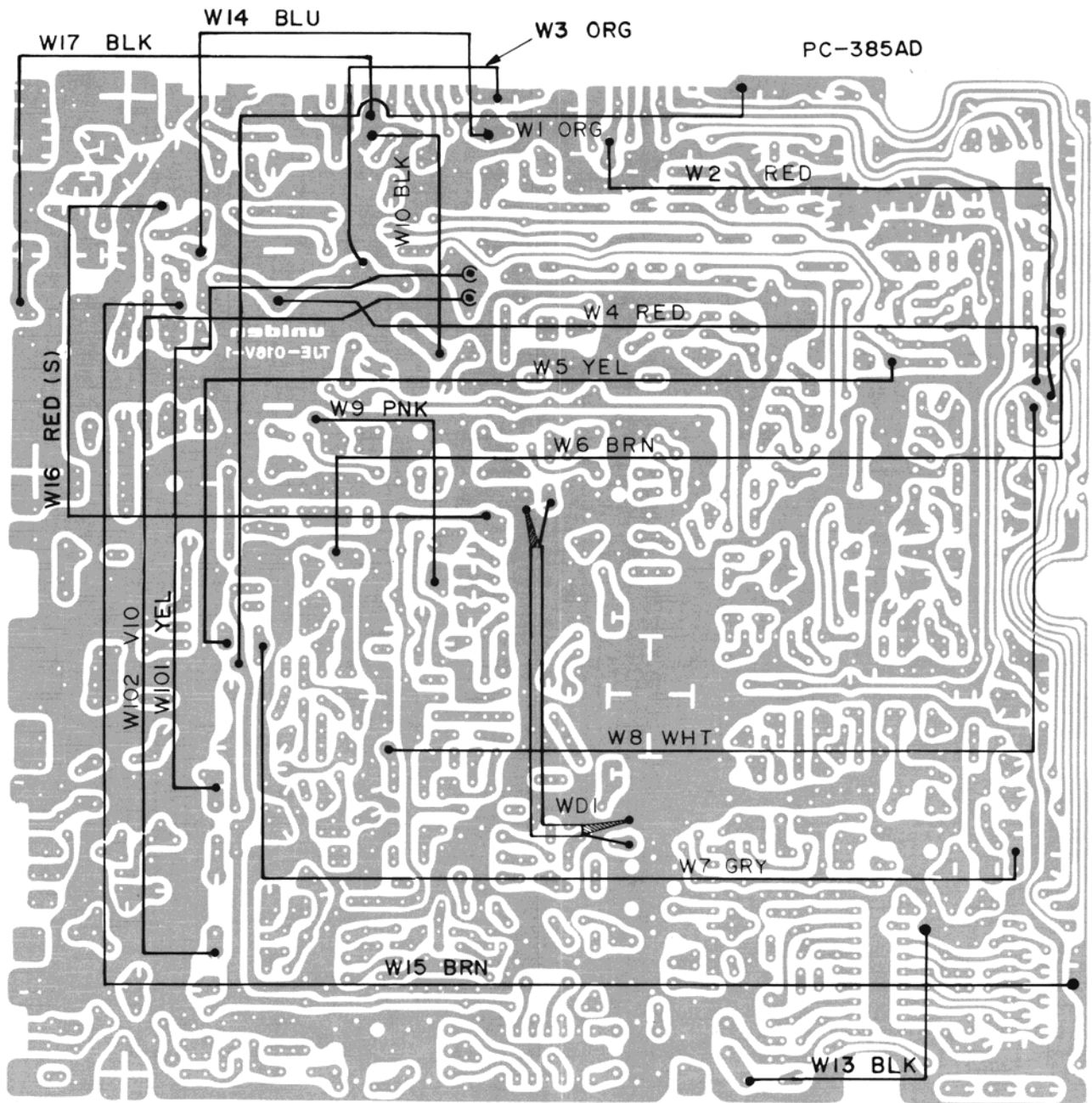

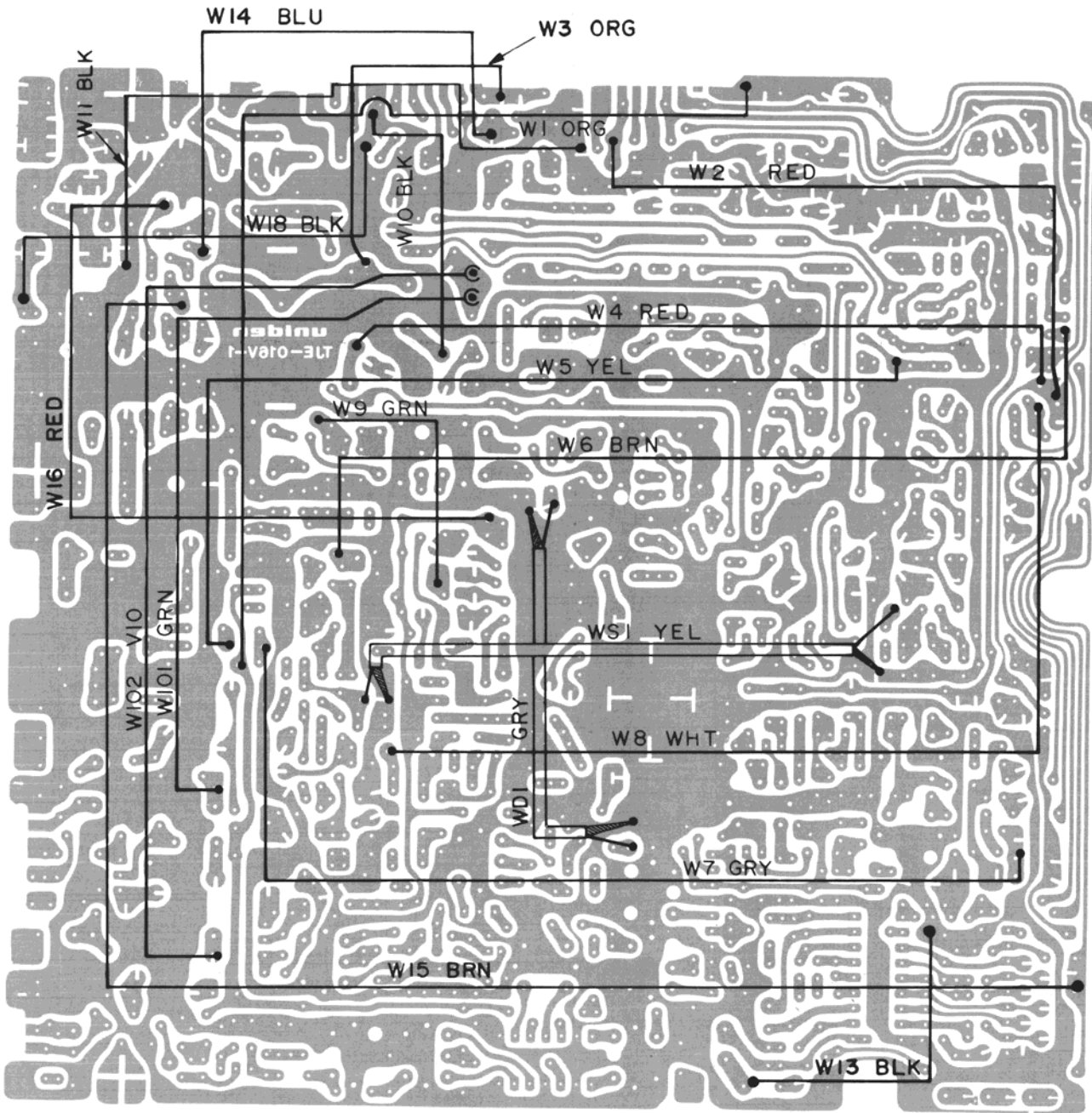

PC-385AD

STALKER IX

Computer No.	Symbol No.	Part No.	Description
D1696	IC 2	DDEY101001	IC MB8719
D1697	IC 3	DDEY130001	IC AN612
D1698	IC 5	DDEY131001	IC MB3756
D1699	IC 6	DDEY132001	IC SO42P
D1700	IC 1	DDEY133001	IC UHIC 007
D1701	IC 4	DDEY146001	IC TA7222P
B1081	FET 1	DDCY001002	Field Effect Transistor 2SK19 BL
B1011	TR7, 14, 30, 31, 45	DDBY003001	Transistor 2SA733 P
B1065	TR 39	DDBY230001	Transistor 2SC1306
B1054	TR4, 5, 8, 11, 13, 15, 20, 27, 28, 32, 33, 35, 37	DDBY224003	Transistor 2SC945A-Q
D1702	TR 26, 40	DDBY246001	Transistor 2SC496-O
B1068	TR 1, 2, 6, 10, 12, 19, 21, 22, 23, 24, 25, 42	DDBY259001	Transistor 2SC1675 L
B1263	TR 3, 16	DDBY269001	Transistor 2SC1730 L
B1264	TR 38	DDBY272001	Transistor 2SC1973
B1024	TR 36	DDBY273001	Transistor 2SC458-C
D1306	TR 34	DDBY278001	Transistor 2SC1419 C
D1703	TR 9, 17, 18	DDBY295002	Transistor 2SC 1674 L
D1704	TR 41	DDBY307003	Transistor 2SC1969-B
D1705	D 13, 14	DDAY090001	Diode MC301
D1706	D402, 410, 411, 412	DDAY100001	Diode, LED TLR 124
D1707	D 405	DDAY116001	Diode, LED TLG124A
D1708	D 46	DDFY020001	Varistor MV-1Y
D1709	D 47	DDFY021001	Varistor MV-13YH
D1710	L 13	LLAY216001	Coil LA 216
D1711	L 17, 19	LLAY217001	Coil LA 217
D1712	L 20	LLAY218001	Coil LA 218
D1713	L 26	LLAY219001	Coil LA 219
D1714	L 28	LLAY220001	Coil LA 220
D1715	L 29	LLAY254001	Coil LA 254
D1716	L 3	LLAY255001	Coil LA 255
D1717	L 18	LLAY256001	Coil LA 256
D1718	L 6	LLAY257001	Coil LA 257
D1719	L 7	LLAY258001	Coil LA 258
D1720	L 8	LLAY259001	Coil LA 259
D1721	L 9	LLAY260001	Coil LA 260
D1722	L 10	LLAY261001	Coil LA 261
D1723	L 5	LLAY262001	Coil LA 262
D1724	L 4	LLAY263001	Coil LA 263
D1725	L 403	LLDY089001	Coil LD 089
D1726	L 30	LLDY096001	Coil LD 096
D1727	L 33, 35	LLDY098001	Coil LD 098
D1728	L 32	LLDY101001	Coil LD 101
D1729	T 1	TTFY147001	Coil AF Choke TF 147
D1730	VR 403, 402	RRVY008001	RV 008 10K ohm A (VOLUME)
D1731	VR 404	RRVY324001	RV 324 10K ohm B (RF GAIN)
D1732	VR 401	RRVY126001	RV 126 100K ohm B (SQUELCH)
D1733	VR 402	RRVY139001	RV 139 20K ohm B (Clarifier)
D1734	X 4	QQXY098001	Crystal 11.1125 QX 098
D1735		PPCY383011	PCB 383 AA CH SW, PCB
D1736		PPCY373011	PCB 373 AA LED PCB

Computer No.	Symbol No.	Part No.	Description
D1737	FT 1	FFLY065001	Filter, Crystal FL065
D1738	S 403	SSRY205001	Switch Rotary SR 205 (Mode)
D1739	S 401	SSRY208001	Switch Rotary SR 208 (CH)
D1740	S 404, 405, 406	SSWY146001	Switch Slide SW 146 PA/CB DIM/BRT, NB-ANL
D1741	M 401	ZMTY097001	Meter MT-097
D1742		WWFY005174	Flat Cable WF005
D1743		WWFY005102	Flat Cable WF005
D1744		WWFY011105	Flat Cable WF011
D1745		MDBP05979	Cover, Top
D1746		MDMP205980	Cover, Bottom
D1747		MDMP206472	Mounting Bracket
D1748		MDMP206472	Panel Front
D1749		MDMP406425	Channel Knob
D1750		MDMP402181	Knob
D1751		MDNP406474	Nameplate, Control
D1752		MDAP406473	Nameplate, Brand
D1753		MDAP406475	Plate Decoration
D1754		MDPP306477	Display Box
D1755		MZPT508801	Owners Manual
D1756		MZPT508807	Schematic Diagram
D1862		AMKY106001	Microphone MK-106

STALKER XV

Computer No.	Symbol No.	Part No.	Description	
D1700	IC-1	DDEY13301	Integrated Circuit	UHIC-007
D1696	IC-2	DDEY101001	Integrated Circuit	MB8719
D1697	IC-3	DDEY130001	Integrated Circuit	AN 612
D1701	IC-4	DDEY146001	Integrated Circuit	TA7222P
D1698	IC-5	DDEY131001	Integrated Circuit	MB3756
D1699	IC-6	DDEY132001	Integrated Circuit	SO42P
B1081	FET-1	DDCY001002	Field Effect Transistor, 2SK19 BL	
B1011	TR 7, 14, 30, 31, 45	DDBY003001	Transistor	2SA733P
B1054	TR 4, 5, 8, 11, 13, 15, 20, 27, 28, 29, 32, 33, 35, 37, 44, 301	DDBY224003	Transistor	2SC945A-Q
B1036	TR 39	DDBY230001	Transistor	2SC1306
D1702	TR 40	DDBY246001	Transistor	2SC496-O
B1068	TR 1, 2, 6, 10, 12, 19, 21, 22, 23, 24, 25, 42	DDBY259001	Transistor	2SC1675-L
B1263	TR3, 16	DDBY269001	Transistor	2SC1730-L
B1264	TR 38	DDBY272001	Transistor	2SC1973
B1024	TR 36	DDBY273001	Transistor	2SC458-C
D1306	TR 34, 302	DDBY278002	Transistor	2SC1419-C
D1703	TR 9, 17, 18	DDBY295002	Transistor	2SC1614-L
D1704	TR 41	DDBY307001	Transistor	2SC1969-B
E1207	TR 401	DDBY403001	Transistor	2SD188-M
C1051	D 1, 2, 9, 21, 22, 42, 53	DDAY001004	Diode	IN60
E1006	D 407	DDAY002002	Diode	SRIK-2
E1007	D 3, 4, 5, 6, 7, 8, 10, 11, 12, 15, 16, 17, 18, 19, 20, 23, 24, 25, 26, 27, 28, 29, 30, 31, 32, 33, 34, 35, 36, 38, 39, 40, 41, 43, 44, 48, 49, 50, 61, 62, 64	DDAY047001	Diode	1S1588
B1267	D 37	DDAY067001	Diode, Vari Cap	1S2687-D
D1705	D 13, 14	DDAY090001	Diode	MC 301
D1210	D 401	DDAY078001	Diode, LED	TLR 321
D1706	D 410, 411, 412	DDAY100001	Diode, LED	TLR 124
C1150	D 402	DDAY007001	Diode, LED	TLR 104
D1708	D 46	DDFY020001	Varistor	MV 1Y
D1709	D 47	DDFY021001	Varistor	MV 13YH
C1151	D 405	DDAY032001	Diode, LED	TLG103
D1394	D 408	DDAY066001	Diode	S5VB10
E1000	D 301	DDAY008001	Diode, Zenor	WZ061
E1001	D 302	DDAY009003	Diode, Zenor	BZ 162
C1194	L 1	LLAY038001	Coil	LA038
C1218	L 27	LLAY160001	Coil	LA160
D1345	L 2	LLAY179001	Coil	LA179
D1344	L 14	LLAY195001	Coil	LA195
D1710	L 13	LLAY216001	Coil	LA216
D1711	L 17, 19	LLAY217001	Coil	LA217
D1712	L 20	LLAY218001	Coil	LA218
D1713	L 26	LLAY219001	Coil	LA219

Computer No.	Symbol No.	Part No.	Description
D1714	L 28	LLAY220001	Coil LA220
D1715	L 29	LLAY254001	Coil LA254
D1716	L 3	LLAY255001	Coil LA255
D1717	L 18	LLAY256001	Coil LA256
D1718	L 6	LLAY257001	Coil LA257
D1719	L 7	LLAY258001	Coil LA258
D1720	L 8	LLAY259001	Coil LA259
D1721	L 9	LLAY260001	Coil LA260
D1722	L 10	LLAY261001	Coil LA261
D1723	L 5	LLAY262001	Coil LA262
D1724	L 4	LLAY263001	Coil LA263
E1155	L 36, 39	LLCY019001	Coil LC019
D1350	L 401, 402	LLDY013001	Coil LD013
C1204	L 50, 51, 52, 404, 405	LLDY077001	Coil LD077
D1580	L 31, 34	LLDY087001	Coil LD087
D1725	L 403, 406, 407, 408	LLDY089001	Coil LD089
D1726	L 30	LLDY096001	Coil LD096
D1727	L 33, 35	LLDY098001	Coil LD098
D1728	L 32	LLDY101001	Coil LD101
E1159	L 409, 410	LLDY027001	Coil LD027
C1203	L 37, 38	LLEY051011	Coil LE051
D1405	L 12, 25	LLZY012001	Inductor, Molded LZ012, 100uH
B1281	L 11, 15, 16, 21, 22, 23, 24	LLZY012004	Inductor, Molded LZ012 400uH
C1193	T401	TTFY143001	Transformer, Power TF 143
E1202	VR 8	RRVY189002	Res. Semi Fixed RV 189 500 ohm B
E1203	VR 2	RRVY189003	Res. Semi Fixed RV 189 1K ohm B
E1204	VR 3	RRVY189004	Res. Semi Fixed RV 189 3K ohm B
E1205	VR 6, 9	RRVY189010	Res. Semi Fixed RV 189 5K ohm B
E1206	VR 1, 5, 7	RRVY189005	Res. Semi Fixed RV 189 10K ohm B
D1776	VR 10, 12	RRVY189008	Res. Semi Fixed RV 189 100K ohm B
E1207	RT 301	RRVY146002	Res. Semi Fixed RV 146 300 ohm B
D1730	VR 403, S402	RRVY008001	10K ohm A VOLUME Resistor, Variable
D1731	VR 404	RRVY324001	Resistor Variable, 10K ohm B RF Gain
D1732	VR 401	RRVY126001	Resistor Variable, 100K ohm B Squelch
D1733	VR 402	RRVY139001	Resistor Variable, 20K ohm B Clarifier
E1208	VR 405	RRVY036001	Resistor Variable, 10K ohm A Mike Gain
B1206	CC 1	HHAY003001	Capacitor Array, HA 003
D1378	CT 1, 2, 3	CCVY028004	Capacitor, Trimmer CV028 20pF
B1217	X 1	QQXY077001	Crystal QX 007 10.24 MHz
C1152	X 3	QQXY083001	Crystal QX 083 7.7975 MHz
C1153	X 2	QQXY084001	Crystal QX 084 7.8025 MHz
D1734	X 4	QQXY098001	Crystal QX 098 11.1125 MHz
E1209		PPCY385014	PC-385AD Main PCB PC Board
E1210		PPCY395011	PC-395AA CH, SW PCB
E1211		PPCY460011	PC-460AA, CH, LED, PCB
E1212		PPCY459011	PC-459AA, Mic Jack PCB

Computer No.	Symbol No.	Part No.	Description
E1213		PPCY458011	PC-458AA Mode LED PCB
E1214		PPCY457011	PC-457AA Push SW PCB
E1215		PPCY461011	PC-461AA Phone Jack PCB
E1216		PPCY372011	PC-372AA Filter PCB
E1217		PPCY006052	PC-006EB PWR Supply PCB
E1218		PPCY401011	PC-401AA SP Jack PCB
D1737	FT-1	FFLY065001	Filter, Crystal FL 065
D1377	FT 2	FFLY046001	Filter, Crystal FL 046
D1738	S403	SSRY205001	Switch Rotary SR 205 (Mode)
D1739	S401	SSRY208001	Switch Rotary SR 208 (CH/SW)
E1219	S404, 405, 408	SSWY144001	Switch Push SW144 (PA, CB, NB/ANL, MOD)
E1220	S409	SSWY099001	Switch Slide SW099 (AC-DC, SW)
E1221	SP 401	ASPY050001	Speaker SP 050
E1222	M 401	ZMTY135001	Meter Mt 135
J1181		AMKY108001	Microphone MK-108
D1326		ZCKY007001	Clock, Digital CK 007
E1223	J 406	JJKY005002	Jack, Phone JK 005
E1224	J 401, 402	JJKY010001	Jack JK-010 PA SP, EXT. SP
C1131	J 403	JJKY052001	Receptacle, DC Power JK 052
E1225	J 405	JJKY068001	Connector, M Type, ANT, JK 068
E1226	J 404	JJKY107001	Jack, Microphone JK 107
E1227	PL 401	VPLY065001	Pilot Lamp PL 065 250m/m
E1228		ZFHY002001	Holder, Fuse FH 002
E1229	F 401, 402	ZFSY012006	Fuse 4 A FS012
E1230		WWZY022001	AC Power Cord WZ 022
E1231		WZDZ070273	DC Power Cord W070
E1232		MDPP306553	Display Box
E1233		MZPT509401	Owners Manual
E1234		MZPT509407	Schematic Diagram/Bill of Material